

### Features

- Ultra-low  $Q_G$  For High Efficiency
- Logic Level
- Light Weight
- Compact Hermetic Package
- Source Sense Pin
- Total Ionizing Dose LDR Immune
- Total Ionizing Dose HDR Immune
- Single Event Effect (SEE) Hardened
  - SEE immunity for LET of 83.2 MeV/(mg/cm<sup>2</sup>) in Si with  $V_{DS}$  up to 100% of rated Breakdown
- Neutron
  - Maintains Pre-Rad specification for up to  $4 \times 10^{15}$  Neutrons/cm<sup>2</sup>



## EPC7004BSH

**Rad-Hard eGaN® 100 V, 46 A,  
16 mΩ typ Surface Mount (FSMD-B)**

### Description

EPC Space FSMD-B series of eGaN® power switching HEMTs have been specifically designed for critical applications in Space and other the high reliability environments. These devices have exceptionally high electron mobility and a low temperature coefficient resulting in very low  $R_{DS(on)}$  values. The lateral structure of the die provides for very low gate charge ( $Q_G$ ) and extremely fast switching times. These features enable faster power supply switching frequencies resulting in higher power densities, higher efficiencies and more compact packaging.

### Applications

- Satellite and Avionics
- Deep Space Probes
- High Speed Rad-Hard DC-DC Conversion
- Rad-Hard Motor Controllers
- Nuclear Facilities

### Thermal Characteristics

Symbol	Parameter-Conditions	Value	Units
$R_{\theta JA}$	Thermal Resistance Junction to Ambient (Note 3)	35	°C/W
$R_{\theta JC}$	Thermal Resistance Junction to Case	2.25	

### I/O Pin Assignment (Bottom View)

Pin	Symbol	Description
1	G	Gate
2	D	Drain
3	S	Source
4	SS	Source Sense

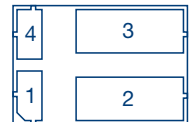

### Absolute Maximum Rating ( $T_C = 25^\circ\text{C}$ unless otherwise noted)

Symbol	Parameter-Conditions	Value	Units
$V_{DS}$	Drain to Source Voltage (Note 1)	100	V
$I_D$	Continuous Drain Current $I_D$ @ $V_{GS} = 5\text{ V}$ , $T_C = 25^\circ\text{C}$	46	A
$I_{DM}$	Single-Pulse Drain Current $t_{pulse} \leq 80\ \mu\text{s}$	184	
$V_{GS}$	Gate to Source Voltage (Note 2)	+6 / -4	V
$T_J, T_{STG}$	Operating and Storage Junction Temperature Range	-55 to +150	°C
$T_{sol}$	Package Mounting Surface Temperature	260	
ESD	ESD Class	1B	
Weight	Device Weight	0.135	g

Electrical Characteristics ( $T_C = 25^\circ\text{C}$  unless otherwise noted. Typical (TYP) values are for reference only.)

Parameter	Symbol	Test Conditions	MIN	TYP	MAX	Units
Drain to Source Voltage	$V_{DSMAX}$	$V_G = 0\text{ V}$	100			V
Drain to Source Leakage	$I_{DSS}$	$V_{GS} = 0\text{ V}, V_{DS} = 100\text{ V}$		2	250	$\mu\text{A}$
		$V_{GS} = 0\text{ V}, V_{DS} = 100\text{ V}, T_J = 125^\circ\text{C}$		6	500	
Gate to Source Forward Leakage	$I_{GSSF}$	$V_{GS} = 6\text{ V}$		10	600	$\mu\text{A}$
Gate to Source Forward Leakage		$V_{GS} = 5\text{ V}, T_J = 125^\circ\text{C}$		40	1000	
Gate to Source Reverse Leakage	$I_{GSSR}$	$V_{GS} = -4\text{ V}$		0.01	250	
Gate to Source Threshold Voltage	$V_{GS(th)}$	$V_{DS} = V_{GS}, I_D = 8\text{ mA}$	0.8	1.4	2.5	V
Gate to Source Threshold Voltage Temperature Coefficient	$\Delta V_{GS(th)} / \Delta T$			1.26		$\text{mV}/^\circ\text{C}$
Drain to Source Resistance (Note 4)	$R_{DS(on)}$	$V_{GS} = 5\text{ V}, I_D = 46\text{ A}$		13	16	$\text{m}\Omega$
Source to Drain Forward Voltage	$V_{SD}$	$V_{GS} = 0\text{ V}, I_S = 0.5\text{ A}$		1.7	3	V

Dynamic Characteristics ( $T_C = 25^\circ\text{C}$  unless otherwise noted. Typical (TYP) values are for reference only.)

Parameter	Symbol	Test Conditions	MIN	TYP	MAX	Units
Input Capacitance	$C_{ISS}$	$V_{DS} = 50\text{ V}, V_{GS} = 0\text{ V}$		797	1400	$\text{pF}$
Reverse transfer Capacitance	$C_{RSS}$			1.8	30	
Output Capacitance	$C_{OSS}$			411	700	
Effective Output Capacitance, Energy Related	$C_{OSS(ER)}$	$V_{DS} = 0\text{ to }50\text{ V}, V_{GS} = 0\text{ V}$		522		$\text{pF}$
Effective Output Capacitance, Time Related	$C_{OSS(TR)}$			690		
Total Gate Charge (Note 6)	$Q_G$	$V_{DS} = 50\text{ V}, V_{GS} = 5\text{ V}, I_D = 30\text{ A}$		7	11	$\text{nC}$
Gate to Source Charge (Note 6)	$Q_{GS}$	$V_{DS} = 50\text{ V}, I_D = 30\text{ A}$		2.4	6	
Gate to Drain Charge (Note 6)	$Q_{GD}$			1.7	3.5	
Output Charge (Note 5)	$Q_{OSS}$	$V_{DS} = 50\text{ V}, V_{GS} = 0\text{ V}$		35		
Source to Drain Recovery Charge (Note 5)	$Q_{RR}$	$I_D = 30\text{ A}, V_{DS} = 50\text{ V}$		0		

### Radiation Characteristics

Every manufacturing lot is tested for total ionizing dose of 1 Mrad of Gamma radiation exposure with an in-situ bias for the following conditions:

ON |  $V_{GS} = 5\text{ V}$   
 NO BIAS |  $V_{DS} = V_{GS} = 0\text{ V}$   
 OFF |  $V_{DS} = 80\% B_{VDSS}$

**Electrical Characteristics up to 1000 krad ( $T_C = 25^\circ\text{C}$  unless otherwise noted. Typical (TYP) values are for reference only.)**

Parameter	Symbol	Test Conditions	MIN	TYP	MAX	Units
Maximum Drain to Source Voltage	$V_{DSMAX}$	$V_{GS} = 0\text{ V}$	100			V
Gate to Source Threshold Voltage	$V_{GS(th)}$	$V_{DS} = V_{GS}, I_D = 8\text{ mA}$	0.8	1.4	2.5	
Drain to Source Leakage	$I_{DSS}$	$V_{GS} = 0\text{ V}, V_{DS} = 100\text{ V}$		0.36	250	$\mu\text{A}$
Gate to Source Forward Leakage	$I_{GSSF}$	$V_{GS} = 6\text{ V}$		10	600	
Gate to Source Reverse Leakage	$I_{GSSR}$	$V_{GS} = -4\text{ V}$		0.36	250	
Drain to Source Resistance (Note 4)	$R_{DS(on)}$	$I_D = 46\text{ A}, V_{GS} = 5\text{ V}$		13	16	$\text{m}\Omega$

### Typical Single Event Effect Safe Operating Area

Note : All Radiation Single Event Effects testing are performed in heavy ion environments such as the K-500 Cyclotron at Texas A&M.

Test	Environment			$V_{DS}$ Voltage (V)		
	Ion	LET MeV(mg/cm <sup>2</sup> ) in Si (+/-5%)	Range $\mu\text{m}$ (+/- 7.5%)	Energy MeV (+/-10%)	$V_{GS} = 0\text{ V}$	$V_{GS} = -4\text{ V}$
See SOA	Xe	63.6	71.3	963	100	100
	Au	83.2	121.4	2256	100	100

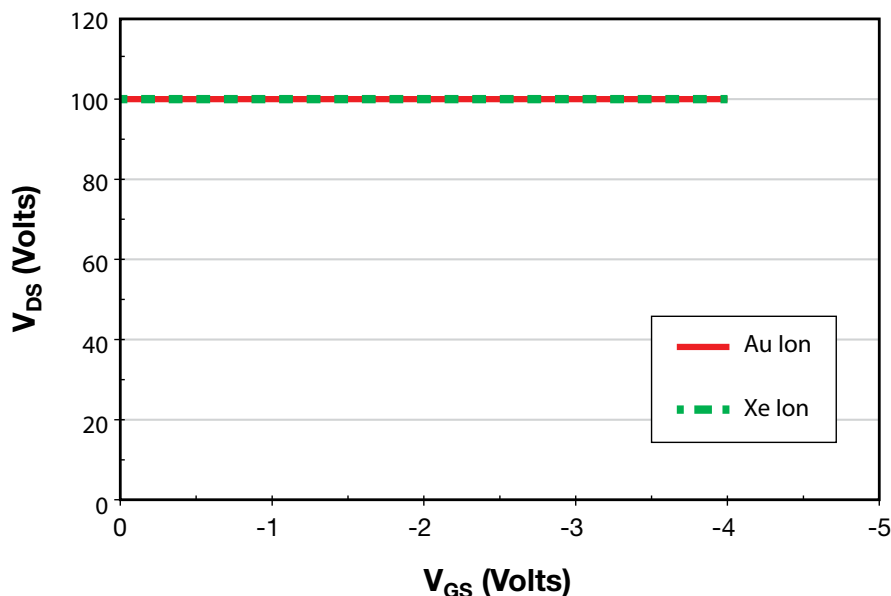

Figure 1. Typical Single Event Effect Safe Operating Area

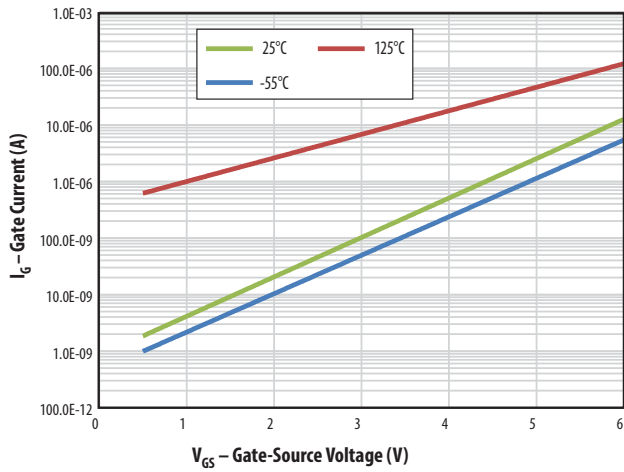

Figure 2. Typical Gate-Source Leakage Current vs. Ambient Temperature

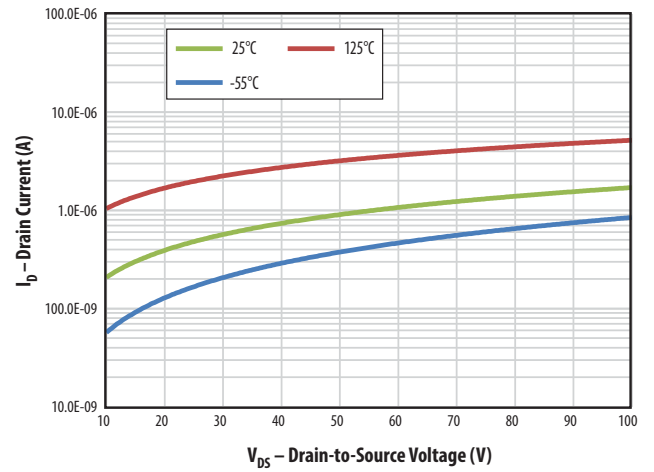

Figure 3. Typical Drain-Source Leakage Current vs. Ambient Temperature

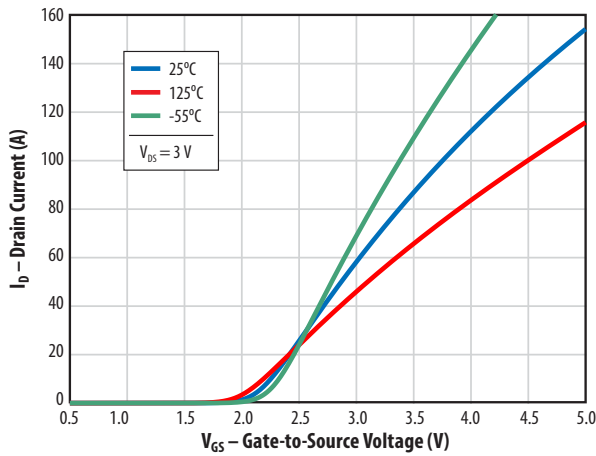

Figure 4. Typical Transfer Characteristics

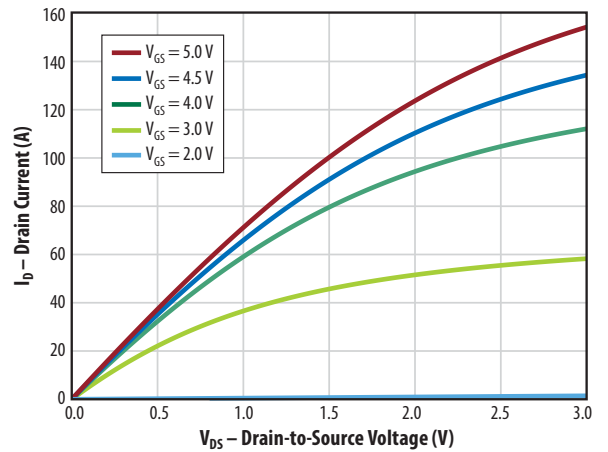

Figure 5. Typical Output Characteristics at  $25^\circ\text{C}$

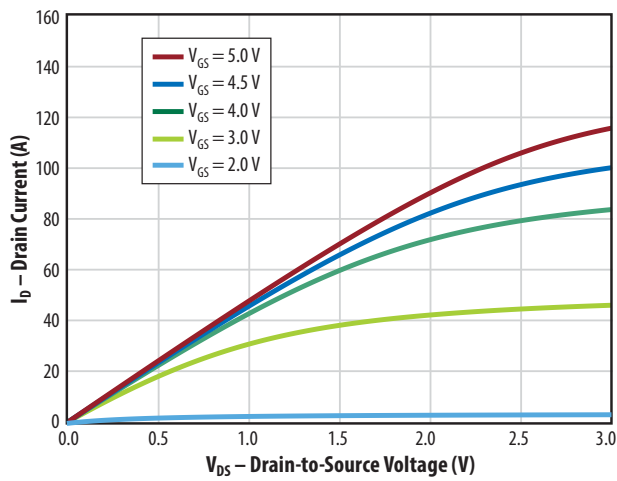

Figure 6. Typical Output Characteristics at 125°C

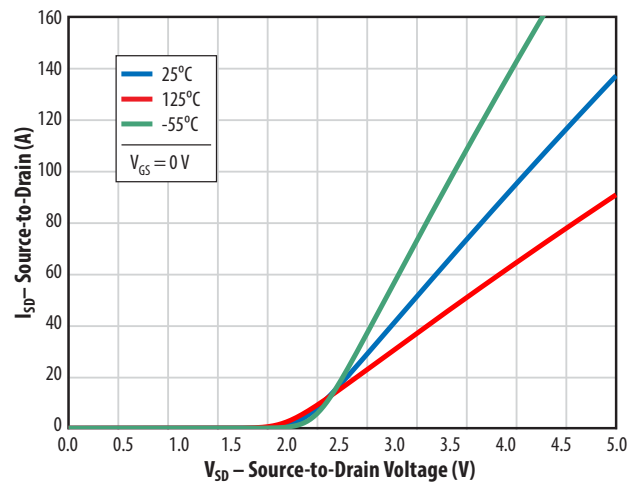

Figure 7. Reverse Drain-Source Characteristics

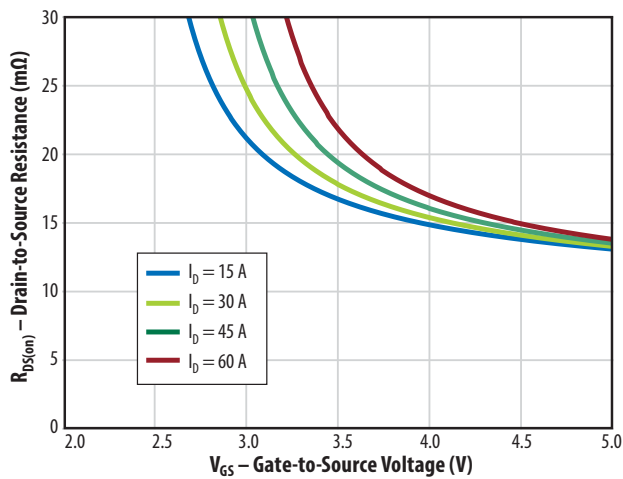

Figure 8.  $R_{DS(on)}$  vs.  $V_{GS}$  for Various Drain Currents

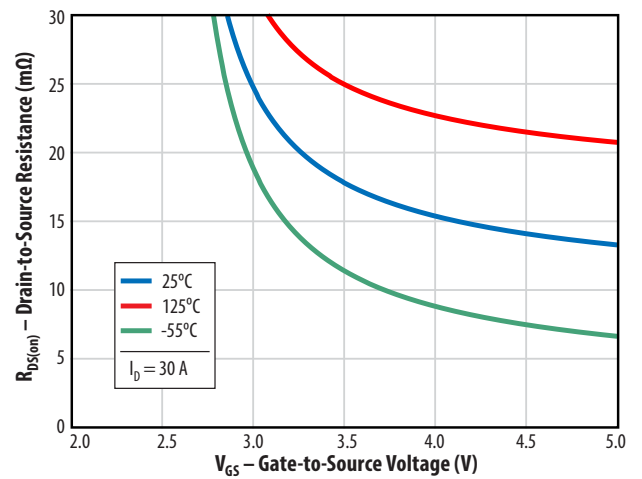

Figure 9.  $R_{DS(on)}$  vs.  $V_{GS}$  for Various Temperatures

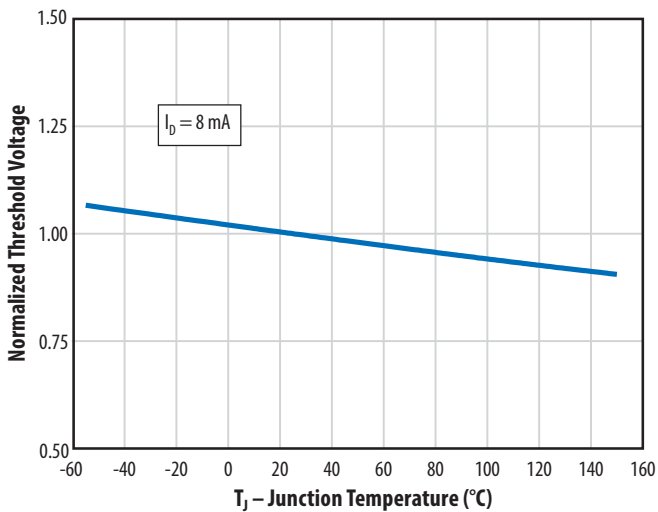

Figure 10. Normalized Threshold Voltage vs. Temperature

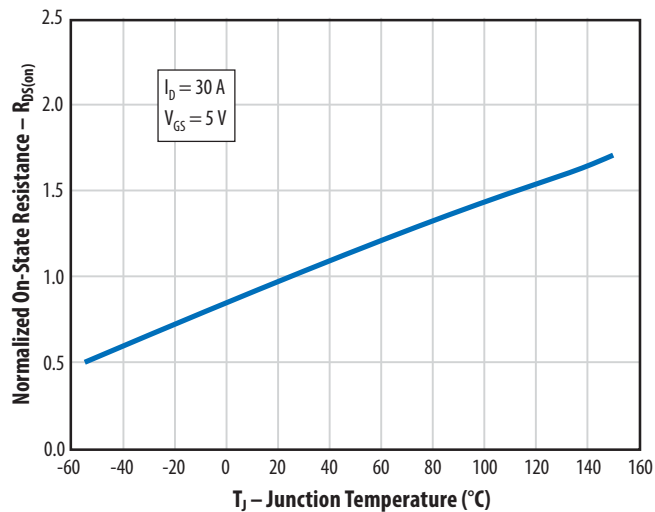

Figure 11. Normalized On-State Resistance vs. Temperature

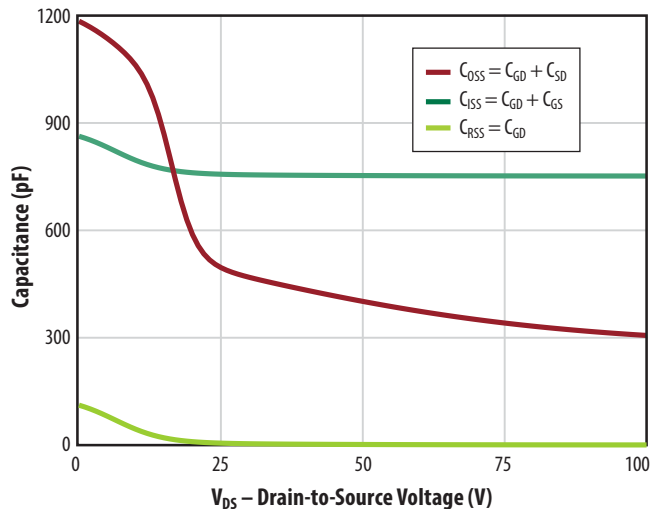

Figure 12. Typical Capacitance

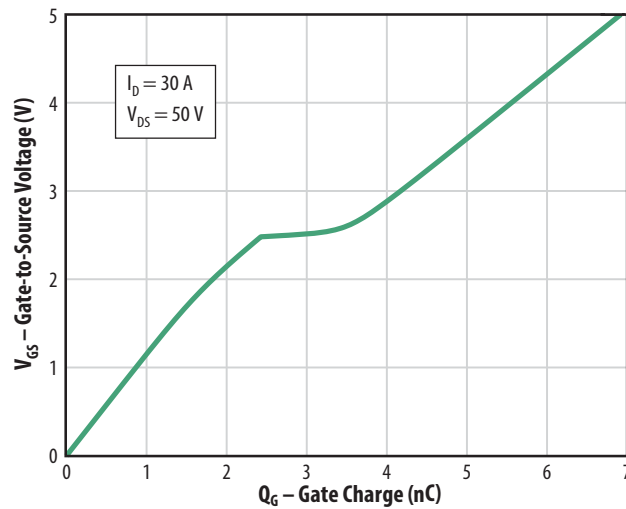

Figure 13. Typical Gate Charge

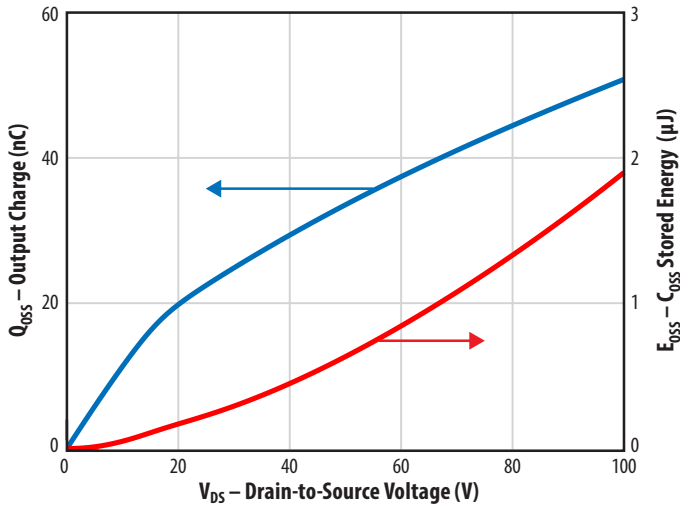

Figure 14. Typical Output Charge and  $C_{OSS}$  Stored Energy

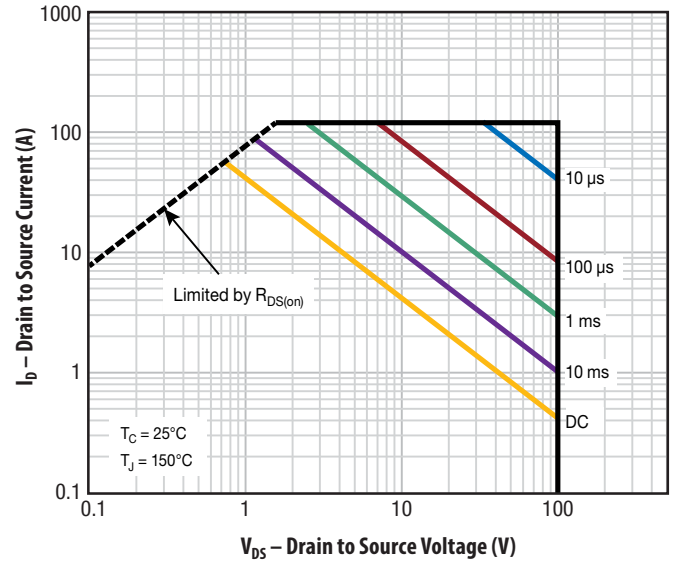

Figure 15. Safe Operating Area

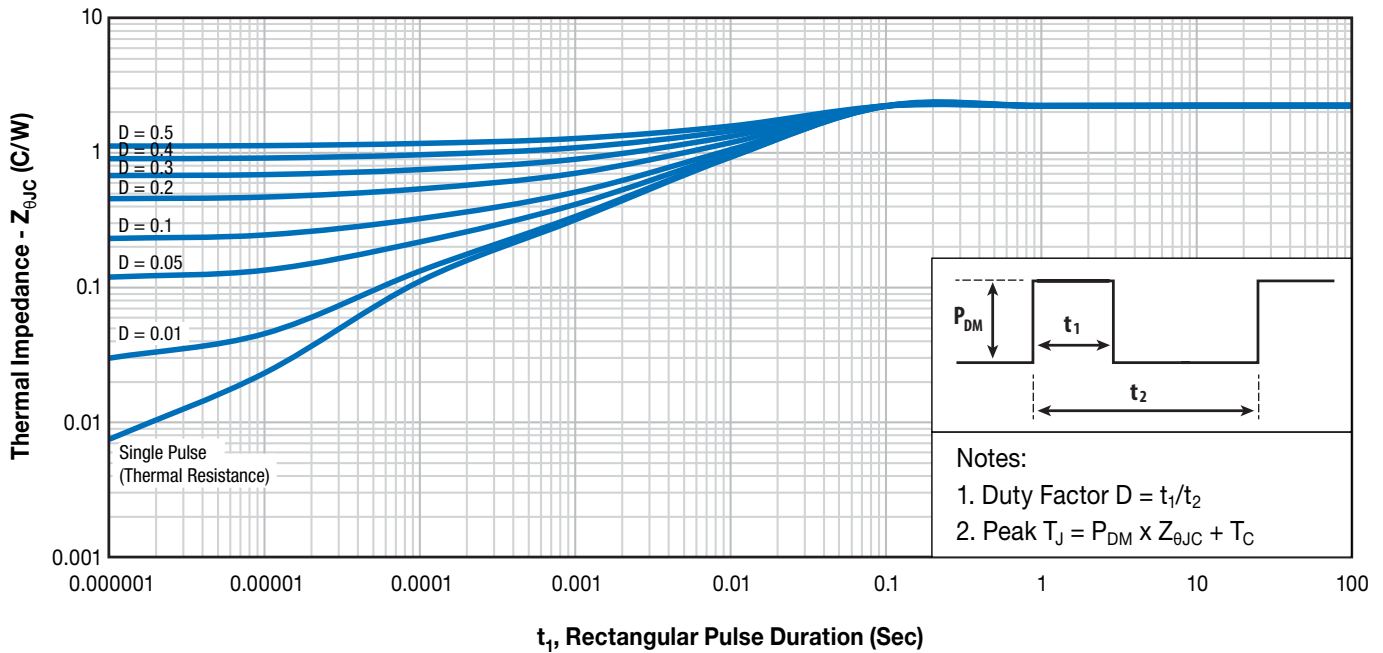
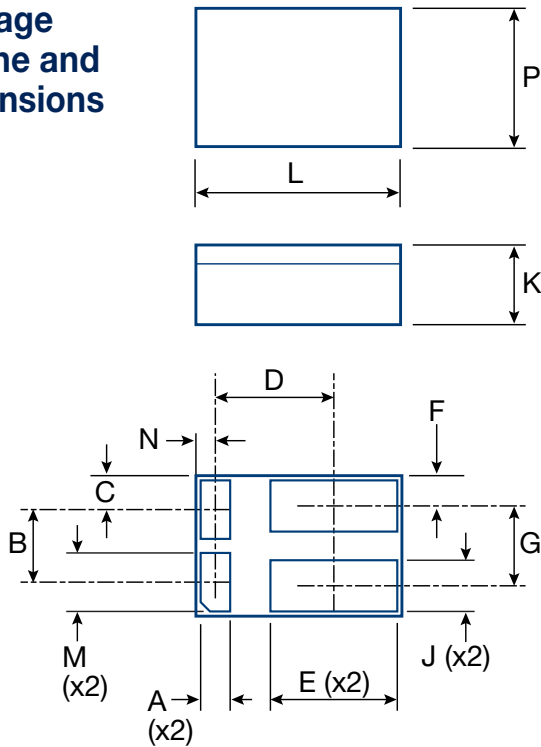

Figure 16. Transient Thermal Impedance, Junction to Case

Package Outline and Dimensions



Symbol	IN		MM	
	NOM	REF	NOM	REF
A	0.032		0.81	
B	0.078		1.98	
C		0.036		0.91
D	0.127		3.23	
E	0.137		3.48	
F		0.032		0.81
G	0.087		2.21	
J	0.05		1.27	
K		0.083		2.11
L	0.22		5.59	
M	0.063		1.6	
N		0.021		0.53
P	0.15		3.81	

Note: All dimensions have a tolerance of  $\pm 0.005$  in [ $\pm 0.13$  mm]  
 Standard Terminal Pad finish is a solder alloy of 63%Sn 37%Pb

Package Connections

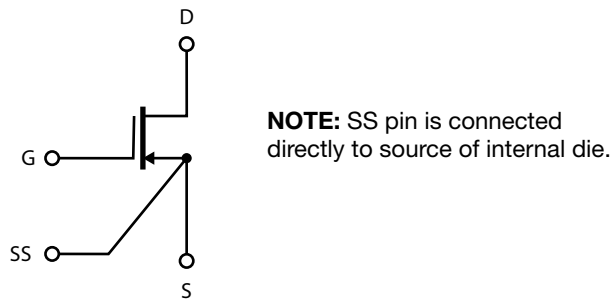

FSMD-B Footprint for Printed Circuit Board Design

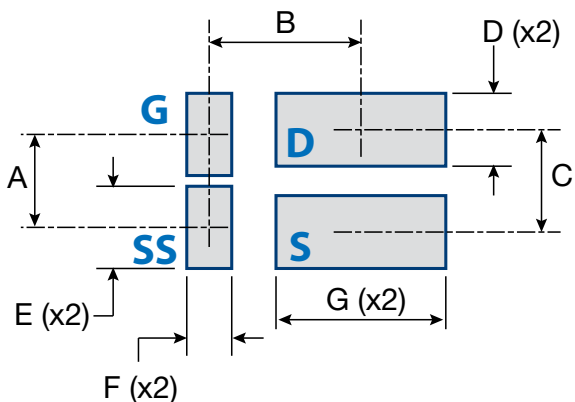

Symbol	IN	MM	Note
	NOM	NOM	
A	0.078	1.98	
B	0.127	3.23	
C	0.087	2.21	
D	0.061	1.55	
E	0.069	1.75	
F	0.038	0.97	
G	0.142	3.61	

Suggested footprint:  
 NOM. DIM = .003 in [0.08 mm] swell on average

## Notes

- Note 1. Never exceed the absolute maximum  $V_{DS}$  of the device otherwise permanent damage/destruction may result.
- Note 2. Never exceed the absolute maximum  $V_{GS}$  of the device otherwise permanent damage/destruction may result. We recommend a  $V_{GS}$  of 5 V for optimum operation across life and radiation.
- Note 3.  $R_{\theta JA}$  measured with FSMD-B package mounted to double-sided PCB, 0.063" thickness with 1.0 square inches of copper area on the top (mounting side) and a flood etch (3 square inches) on the bottom side.
- Note 4. Measured using four wire (Kelvin) sensing and pulse measurement techniques. Measurement pulse width is 80  $\mu$ s and duty cycle is 1%, maximum.
- Note 5. Guaranteed by design/device construction. Not tested.
- Note 6. Guaranteed by design/device construction. Not tested. The gate charge parameters are measured based on the MIL-STD-750.3471 Condition B. A high speed constant gate current ( $I_{const}$ ) is provided to the Gate of the DUT during the time that the ground switch ( $G_S$ ) is OFF ( $t_{off}$ ). The DUT is switched ON and OFF using ground-sensed switch  $G_S$ . The gate current is adjusted to yield the desired charge per unit time ( $I_{const} \cdot \text{time per division}$ ) on the measuring oscilloscope. The  $G_S$  pulse drive ON time ( $t_{on}$ ) is adjusted for the desired observability of the gate-source voltage ( $V_{GS}$ ) waveform. The maximum duty cycle of the ground switch  $t_{off}/t_{on}$  should be set to 1% maximum. Please note that all gate-related signals are referenced to the "Source Sense" pin on the package. At all times during the measurement, the maximum gate-source voltage is clamped to 5  $V_{DC}$ .

## Disclaimers

ALL PRODUCT, PRODUCT SPECIFICATIONS AND DATA ARE SUBJECT TO CHANGE WITHOUT NOTICE TO IMPROVE RELIABILITY, FUNCTION OR DESIGN OR OTHERWISE. EPC Space Corporation, its affiliates, agents, employees, and all persons acting on its or their behalf (collectively, "EPC Space"), disclaim any and all liability for any errors, inaccuracies or incompleteness contained in any datasheet or in any other disclosure relating to any product. EPC Space makes no warranty, representation or guarantee regarding the suitability of the products for any particular purpose. To the maximum extent permitted by applicable law, EPC Space disclaims (i) any and all liability arising out of the application or use of any product, (ii) any and all liability, including without limitation special, consequential or incidental damages, and (iii) any and all implied warranties, including warranties of fitness for particular purpose, non-infringement and merchantability. Statements regarding the suitability of products for certain types of applications are based on EPC Space market knowledge of typical requirements that are often placed on similar technologies in generic applications. Product specifications do not expand or otherwise modify EPC Space terms and conditions of purchase, including but not limited to the warranty expressed therein. Except as expressly indicated in writing, EPC Space products are not designed for use in medical, life-saving, or life-sustaining applications or for any other application in which the failure of the EPC Space product could result in personal injury or death. Customers using EPC Space products not expressly indicated for use in such applications do so at their own risk. Please contact authorized EPC Space personnel to obtain written terms and conditions regarding products designed for such applications. No license, express or implied, by estoppel or otherwise, to any intellectual property rights is granted by this document or by any conduct of EPC Space. Product names and markings noted herein may be trademarks of their respective owners.

## Export Administration Regulations (EAR)

The products described in this datasheet are subject to the U.S. Export Administration Regulations (EAR), 15 C.F.R. Pts 730-774, and are classified in ECCN 9A515.e. These products may not be exported, reexported, or transferred (in country) to any foreign country, or foreign entity, by any means, except in accordance with the requirements of such regulations.

## Patents

EPC Corporation and EPC Space hold numerous worldwide patents. Any that apply to the product(s) listed in this document are identified by markings on the product(s) or on internal components of the product(s) in accordance with local patent laws.

*eGaN<sup>®</sup> is a registered trademark of Efficient Power Conversion Corporation, Inc. Data and specification subject to change without notice.*

Information subject to change without notice.