

### Features

- Ultra-low  $Q_G$  For High Efficiency
- Logic Level
- Light Weight
- Compact Hermetic Package Dual Gate
- Source Sense Pin
- Total Ionizing Dose LDR Immune
- Total Ionizing Dose HDR Immune



### EPC7030MC

**Rad-Hard eGaN® 300 V, 50 A,  
26 mΩ Surface Mount (FSMD-M)**

### Description

EPC Space FSMD-M series of eGaN® power switching HEMTs have been specifically designed for critical applications in Space and other the high reliability environments. These devices have exceptionally high electron mobility and a low temperature coefficient resulting in very low  $R_{DS(on)}$  values. The lateral structure of the die provides for very low gate charge ( $Q_G$ ) and extremely fast switching times. These features enable faster power supply switching frequencies resulting in higher power densities, higher efficiencies and more compact packaging.

### Applications

- Satellite and Avionics
- Deep Space Probes
- High Speed Rad-Hard DC-DC Conversion
- Rad-Hard Motor Controllers
- Nuclear Facilities

### Thermal Characteristics

Symbol	Parameter-Conditions	Value	Units
$R_{\theta JA}$	Thermal Resistance Junction to Ambient (Note 3)	35	°C/W
$R_{\theta JC}$	Thermal Resistance Junction to Case	0.94	

### I/O Pin Assignment (Bottom View)

Pin	Symbol	Description
1	G	Gate
2	D	Drain
3	S	Source
4	SS	Source Sense

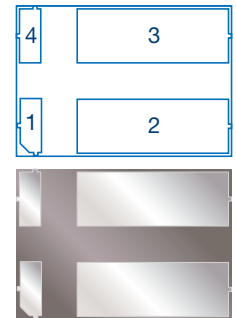

### Absolute Maximum Rating ( $T_C = 25^\circ\text{C}$ unless otherwise noted)

Symbol	Parameter-Conditions	Value	Units
$V_{DS}$	Drain to Source Voltage (Note 1)	300	V
	Drain-to-Source Voltage (up to 10,000 5 ms pulses at 150°C)	360	
$I_D$	Continuous Drain Current $I_D$ @ $V_{GS} = 5\text{ V}$	50	A
$I_{DM}$	Single-Pulse Drain Current $t_{pulse} = 300\ \mu\text{s}$	150	
$V_{GS}$	Gate to Source Voltage (Note 2)	+6 / -4	V
$T_J, T_{STG}$	Operating and Storage Junction Temperature Range	-55 to +150	°C
$T_{SOL}$	Package Mounting Surface Temperature	260	
ESD	ESD Class	1B ( $\Delta B$ )	
Weight	Device Weight	0.190	g

## Static Characteristics (Typical (TYP) values are for reference only.)

Parameter	Symbol	Test Conditions	MIN	TYP	MAX	Units	
Maximum Drain to Source Voltage	$V_{DSMAX}$	$V_{GS} = 0\text{ V}$	300			V	
Drain to Source Leakage	$I_{DSS}$	$V_{DS} = 300\text{ V}, V_{GS} = 0\text{ V}$		11	400	$\mu\text{A}$	
		$V_{DS} = 300\text{ V}, V_{GS} = 0\text{ V}$	$T_C = 125^\circ\text{C}$	22	800		
Gate to Source Forward Leakage	$I_{GSSF}$	$V_{GS} = 6\text{ V}$		0.4	600	$\mu\text{A}$	
Gate to Source Forward Leakage		$V_{GS} = 6\text{ V}$	$T_C = 125^\circ\text{C}$	1	1000		
Gate to Source Reverse Leakage	$I_{GSSR}$	$V_{GS} = -4\text{ V}$		5	0.5		
Gate to Source Threshold Voltage	$V_{GS(th)}$	$V_{DS} = V_{GS}, I_D = 18\text{ mA}$	$T_C = 25^\circ\text{C}$	0.8	1.5	2.5	V
Gate to Source Threshold Voltage Temperature Coefficient	$\Delta V_{GS(th)}$		$-55^\circ\text{C} < T_A < 150^\circ\text{C}$		2.0		mV/°C
Drain to Source Resistance (Note 4)	$R_{DS(on)}$	$V_{GS} = 5\text{ V}, I_D = 50\text{ A}$	$T_C = 25^\circ\text{C}$	15	26	m $\Omega$	
Source to Drain Forward Voltage	$V_{SD}$	$I_S = 0.5\text{ A}, V_G = 0\text{ V}$	$T_C = 25^\circ\text{C}$	1.7	3	V	

Dynamic Characteristics ( $T_C = 25^\circ\text{C}$  unless otherwise noted. Typical (TYP) values are for reference only.)

Parameter	Symbol	Test Conditions	MIN	TYP	MAX	Units
Input Capacitance	$C_{ISS}$	$V_{DS} = 150\text{ V}, V_{GS} = 0\text{ V}$		1155		$\mu\text{F}$
Reverse transfer Capacitance	$C_{RSS}$			10		
Output Capacitance	$C_{OSS}$			235		
Effective Output Capacitance, Energy Related (Note 5)	$C_{OSS(ER)}$	$V_{DS} = 0\text{ to }150\text{ V}, V_{GS} = 0\text{ V}$		970		$\mu\text{F}$
Effective Output Capacitance, Time Related (Note 5)	$C_{OSS(TR)}$			1250		
Total Gate Charge (Note 6)	$Q_G$	$V_{DS} = 150\text{ V}, V_{GS} = 5\text{ V}, I_D = 50\text{ A}$		25	30	nC
Gate to Source Charge (Note 6)	$Q_{GS}$			8	10	
Gate to Drain Charge (Note 6)	$Q_{GD}$			4	7	
Output Charge (Note 5)	$Q_{OSS}$	$V_{DS} = 150\text{ V}, V_{GS} = 0\text{ V}$		147		
Source to Drain Recovery Charge (Note 5)	$Q_{RR}$			0		

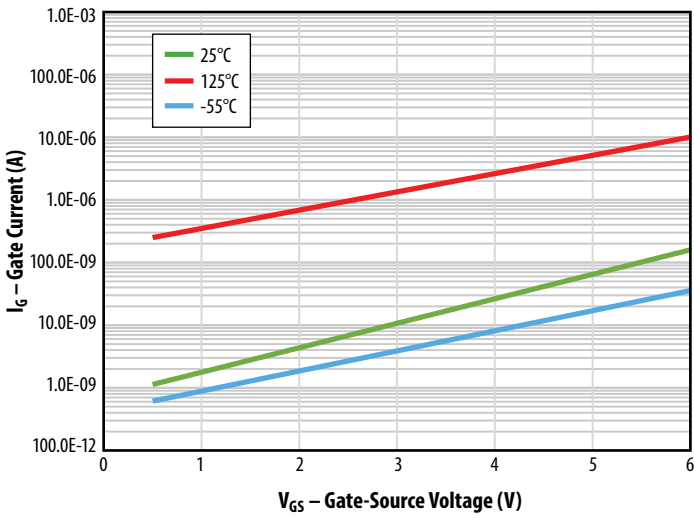

Figure 1: Typical Gate-Source Leakage Current vs. Ambient Temperature

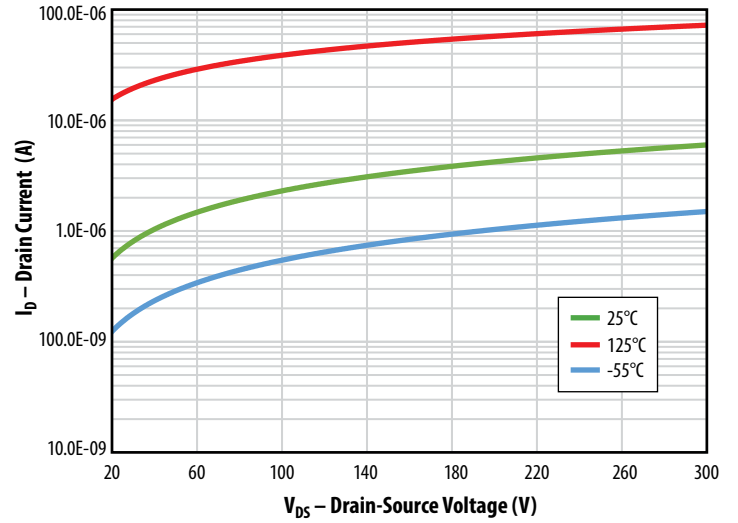

Figure 2: Typical Drain-Source Leakage Current vs. Ambient Temperature

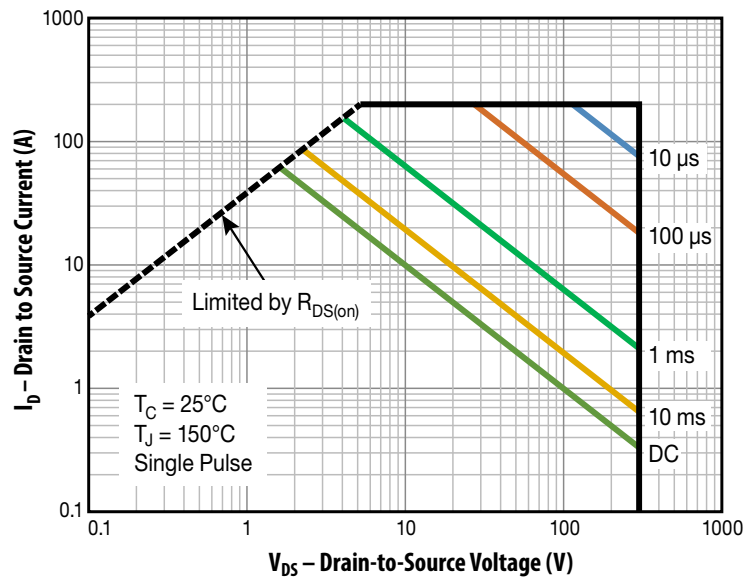

Figure 3: Safe Operating Area

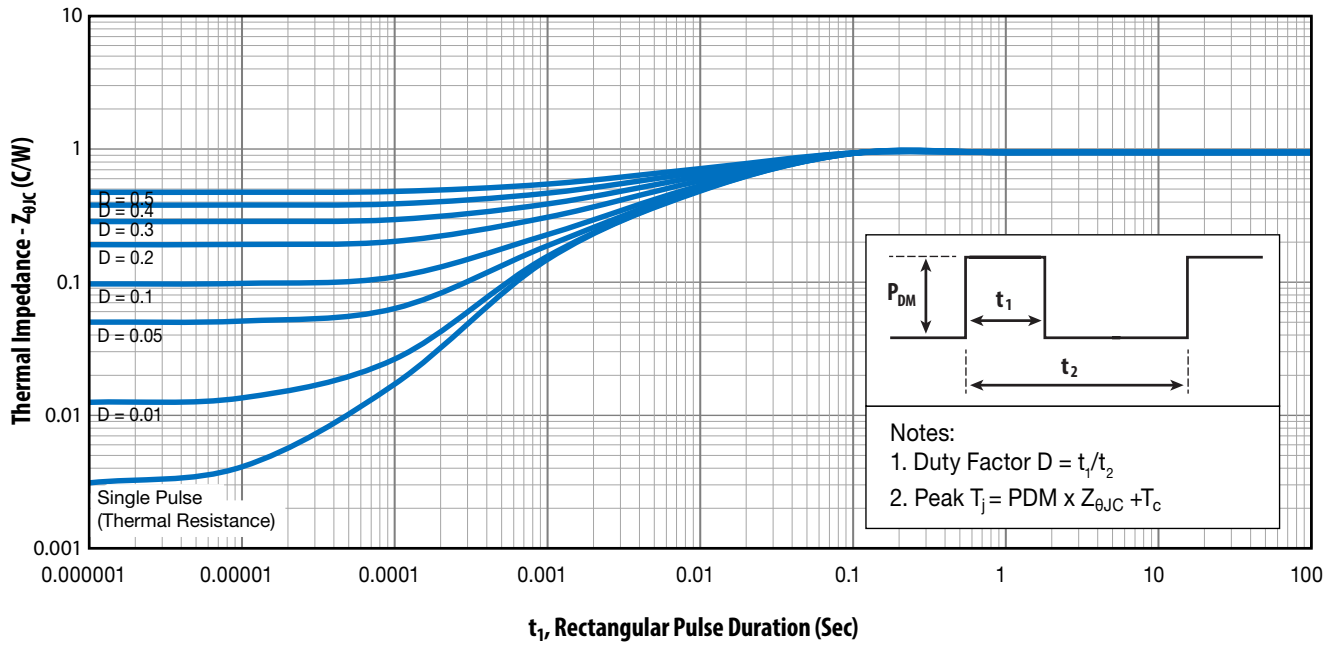
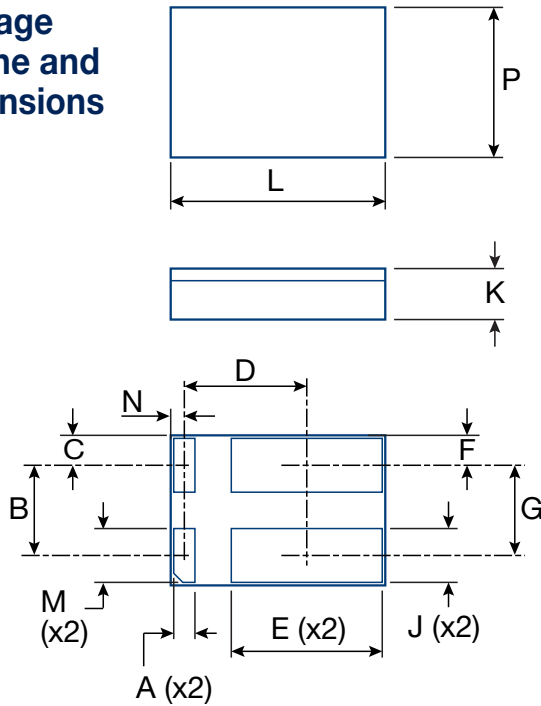

Figure 4: Thermal Impedance diagram

Package Outline and Dimensions



Symbol	IN		MM	
	NOM	REF	NOM	REF
A	0.035		0.89	
B	0.149		3.78	
C		0.049		1.24
D	0.202		5.13	
E	0.249		6.32	
F		0.049		1.24
G	0.149		3.78	
J	0.089		2.26	
K		0.084		2.13
L	0.354		8.99	
M	0.089		2.26	
N		0.022		0.56
P	0.248		6.30	

Note: All dimensions have a tolerance of  $\pm 0.005$  in [ $\pm 0.13$  mm]  
 Standard Terminal Pad finish is a solder alloy of 63%Sn 37%Pb

Package Connections

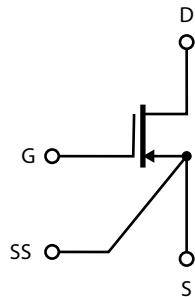

NOTE: SS pin is connected directly to source of internal die.

FSMD-M Footprint for Printed Circuit Board Design

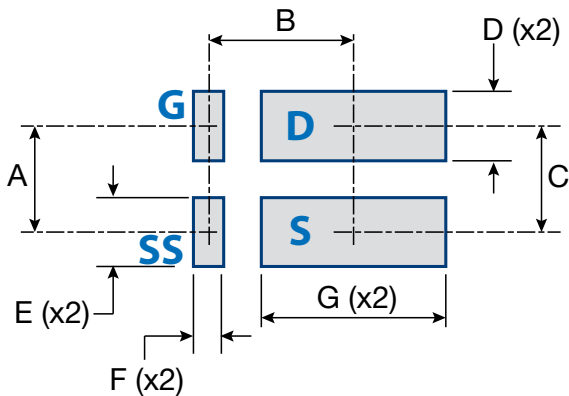

Symbol	IN	MM	Note
	NOM	NOM	
A	0.149	3.78	
B	0.202	5.13	
C	0.149	3.78	
D	0.095	2.41	
E	0.095	2.41	
F	0.041	1.04	
G	0.255	6.48	

Suggested footprint:  
 NOM. DIM = .003 in [0.08 mm] swell on average

## Notes

- Note 1. Never exceed the absolute maximum  $V_{DS}$  of the device otherwise permanent damage/destruction may result.
- Note 2. Never exceed the absolute maximum  $V_{GS}$  of the device otherwise permanent damage/destruction may result. We recommend a  $V_{GS}$  of 5V for optimum operation across life and radiation.
- Note 3.  $R_{\theta JA}$  measured with FSMD-M package mounted to double-sided PCB, 0.063" thickness with 1.0 square inches of copper area on the top (mounting side) and a flood etch (3 square inches) on the bottom side.
- Note 4. Measured using four wire (Kelvin) sensing and pulse measurement techniques. Measurement pulse width is 80  $\mu$ s and duty cycle is 1%, maximum.
- Note 5. Guaranteed by design/device construction. Not tested.
- Note 6. The gate charge parameters are measured based on the MIL-STD-750.3471 Condition B. A high speed constant gate current ( $I_{const}$ ) is provided to the Gate of the DUT during the time that the ground switch ( $G_S$ ) is OFF ( $t_{off}$ ). The DUT is switched ON and OFF using ground-sensed switch  $G_S$ . The gate current is adjusted to yield the desired charge per unit time ( $I_{const} \cdot \text{time per division}$ ) on the measuring oscilloscope. The  $G_S$  pulse drive ON time ( $t_{on}$ ) is adjusted for the desired observability of the gate-source voltage ( $V_{GS}$ ) waveform. The maximum duty cycle of the ground switch ( $t_{off}/t_{on}$ ) should be set to 1% maximum. Please note that all gate-related signals are referenced to the "Source Sense" pin on the package. At all times during the measurement, the maximum gate-source voltage is clamped to 5  $V_{DC}$ .

## Disclaimers

ALL PRODUCT, PRODUCT SPECIFICATIONS AND DATA ARE SUBJECT TO CHANGE WITHOUT NOTICE TO IMPROVE RELIABILITY, FUNCTION OR DESIGN OR OTHERWISE. EPC Space Corporation, its affiliates, agents, employees, and all persons acting on its or their behalf (collectively, "EPC Space"), disclaim any and all liability for any errors, inaccuracies or incompleteness contained in any datasheet or in any other disclosure relating to any product. EPC Space makes no warranty, representation or guarantee regarding the suitability of the products for any particular purpose. To the maximum extent permitted by applicable law, EPC Space disclaims (i) any and all liability arising out of the application or use of any product, (ii) any and all liability, including without limitation special, consequential or incidental damages, and (iii) any and all implied warranties, including warranties of fitness for particular purpose, non-infringement and merchantability. Statements regarding the suitability of products for certain types of applications are based on EPC Space market knowledge of typical requirements that are often placed on similar technologies in generic applications. Product specifications do not expand or otherwise modify EPC Space terms and conditions of purchase, including but not limited to the warranty expressed therein. Except as expressly indicated in writing, EPC Space products are not designed for use in medical, life-saving, or life-sustaining applications or for any other application in which the failure of the EPC Space product could result in personal injury or death. Customers using EPC Space products not expressly indicated for use in such applications do so at their own risk. Please contact authorized EPC Space personnel to obtain written terms and conditions regarding products designed for such applications. No license, express or implied, by estoppel or otherwise, to any intellectual property rights is granted by this document or by any conduct of EPC Space. Product names and markings noted herein may be trademarks of their respective owners.

## Export Administration Regulations (EAR)

The products described in this datasheet are subject to the U.S. Export Administration Regulations (EAR), 15 C.F.R. Pts 730-774, and are classified in ECCN 9A515.e. These products may not be exported, reexported, or transferred (in country) to any foreign country, or foreign entity, by any means, except in accordance with the requirements of such regulations.

## Patents

EPC Corporation and EPC Space hold numerous worldwide patents. Any that apply to the product(s) listed in this document are identified by markings on the product(s) or on internal components of the product(s) in accordance with local patent laws.

*eGaN<sup>®</sup> is a registered trademark of Efficient Power Conversion Corporation, Inc. Data and specification subject to change without notice.*

Information subject to change without notice.