

Package Outline and Dimensions

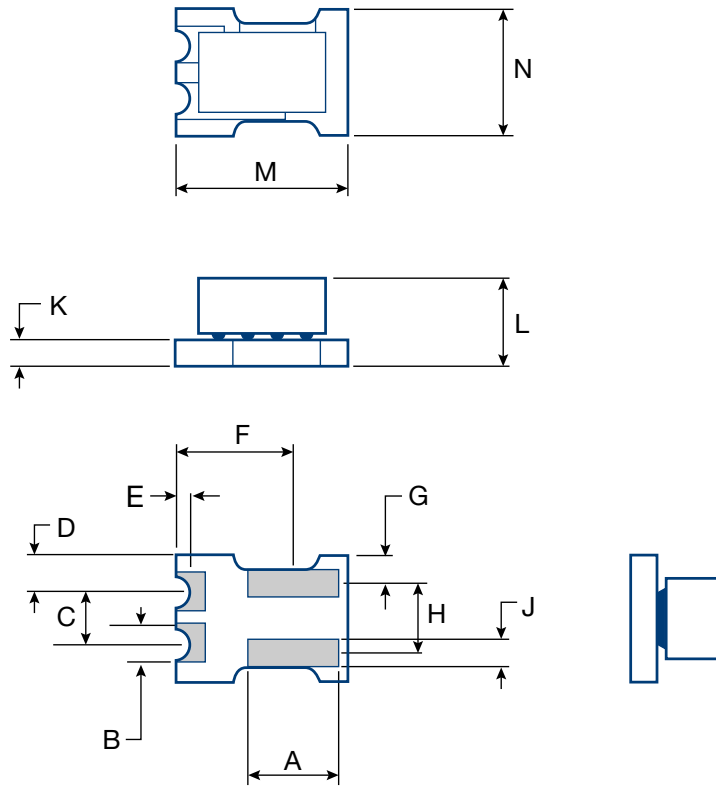

Symbol	Inches	Millimeters	Note
A	0.047	1.193	
B	0.020	0.508	
C	0.028	0.711	
D	0.016	0.406	
E	0.008	0.203	
F	0.063	1.600	
G	0.016	0.406	
H	0.036	0.914	
J	0.015	0.381	
K	0.015	0.381	
L	0.047	1.194	Ref. only
M	0.091	2.311	
N	0.060	1.524	

CDA4 Footprint for Printed Circuit Board Design

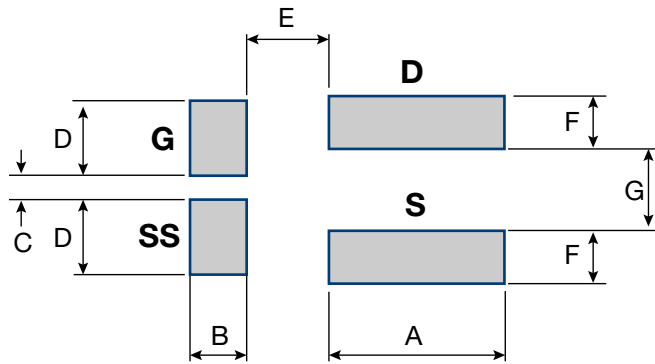

Symbol	Inches	Millimeters	Note
A	0.051	1.295	
B	0.019	0.483	
C	0.008	0.203	
D	0.020	0.508	
E	0.032	0.813	
F	0.020	0.508	
G	0.024	0.610	
H	0.037	0.940	